

VIDEO DOOR ENTRY SYSTEM



EASY AND FLEXIBLE
SOLUTIONS



international DESIGN

The **international DESIGN** of the devices, combined with the technological expertise of the Legrand Group, makes these solutions the **perfect choice** for all houses



- different finishes
- made with strong materials
- flush and wall mounted versions
- wide range of handsets and entrance panels





simple and flexible TECHNOLOGY

■ The solutions ensure a high degree of versatility, capable of meeting the needs of all customers. The 2 WIRE technology gives the possibility of installing an audio door entry system already preset for future transformation into a video system.

■ From the basic door entry system functions, to the more advanced ones, to the integration with home automation applications, or the look integration with the BTicino residential series.

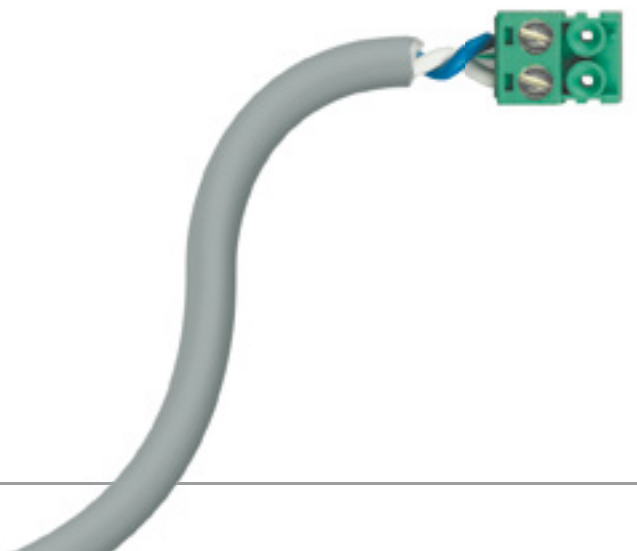

High performances

in terms of expandability and maximum distances reachable, maximum number of pushbuttons and handsets installed.



Prepared for the activation of these functions:

- **intercom**
- **staircase lights**
- **activation of additional cameras**
- **floor call**
- **audio/video call memory**



■ Simplicity and extreme ease of installation with the dedicated kits: all that is required for the installation in one single pack. Intercommunication as standard, and possibility of expansion using the accessories of the 2 WIRE video door entry system range.



One-family or two-family

2 WIRE

■ Ready packed solutions including the new SFERA NEW and SFERA ROBUR entrance panels with a modern design. Wide look and installation range of video handsets. The same expansion possibilities as the 2 WIRE video door entry system



and **multi-family** SOLUTIONS



JUST 2 WIRE

A LOT OF FUNCTIONS

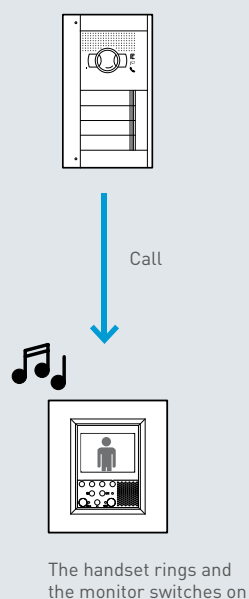

THE CALL

Pressing the call pushbutton on the entrance panel, the system generates a signal that is only recognised by the handsets the call is addressed to (the call will have to be answered within 30 seconds from the moment the pushbutton is pressed). Each handset is configured in a unique specific way. When the call is received, the handset rings and the monitor switches on.

Press the  pushbutton or lift the handset to establish the communication (maximum duration of the communication is 1 minute) with the entrance panel.

Press  again or replace the handset to stop the communication and switch the monitor off.

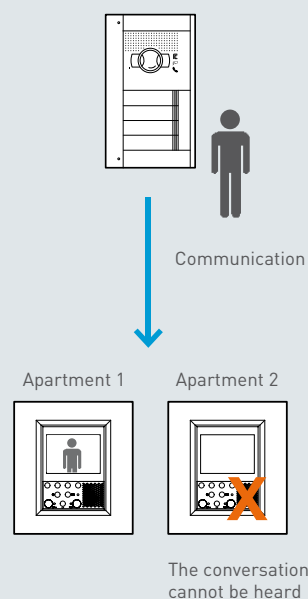

CONVERSATION SECRECY

During the conversation between the entrance panel and the video handsets, all external panels and handsets that are not involved in the conversation are temporarily excluded in order to guarantee the privacy of video door entry conversations. When calling from an entrance panel that is temporarily excluded, a time-out tone will be heard, to indicate that the extension line is momentarily busy.

2 WIRE SYSTEM MAIN FUNCTIONS

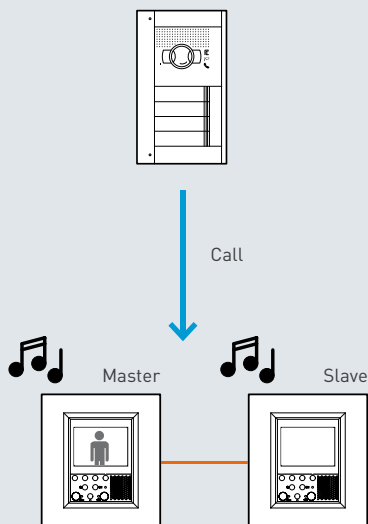

When a call is received, the master comes on, while the SLAVE will only ring.

MASTER-SLAVE FUNCTION

The system offers the MASTER-SLAVE function: when the call is received, all the apartment handsets ring, but only the monitor of the video handset configured as master comes on.

When the auto-switching on key of a SLAVE is pressed, the monitor of the MASTER handset turns off, while the monitor of the SLAVE itself turns on (without necessarily establishing communication with the entrance panel). If the connection key  of a SLAVE is pressed (or the handset is lifted), the MASTER monitor turns off and communication with the audio-video entrance panel is established.

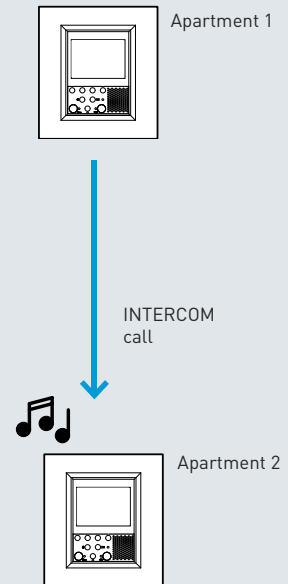

INTERCOM

The system offers an intercom function, with up to 3 minutes communications between audio and video handsets:

- From different apartments
- Within the same apartment

Each handset of the apartment can be called individually.

The intercom connection can be simultaneous to other connections external to the apartment.

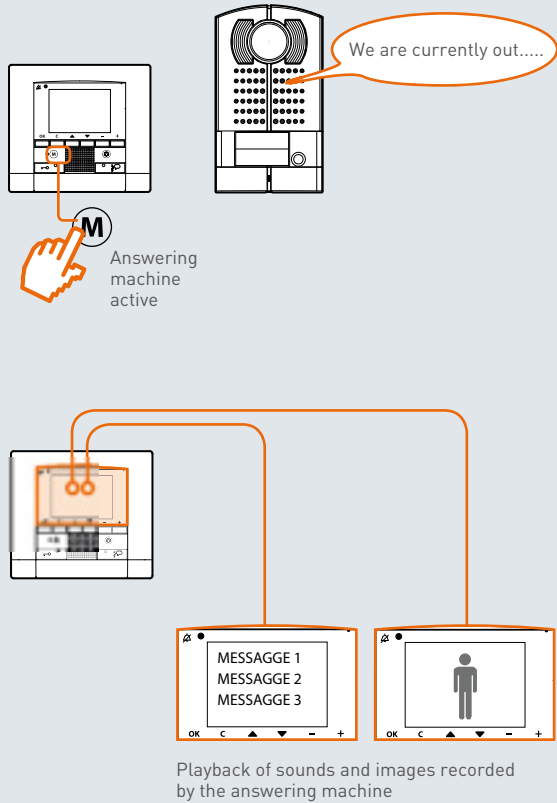

VIDEO DOOR ENTRY SYSTEM ANSWERING MACHINE FUNCTION

Function available only using Polyx Memory Display and Celiane video handsets. It is possible to record voice and images of a call from an entrance panel. It is also possible to record an audio message to play back on the entrance panel following an unanswered call.

The video door entry system message can be recorded in 2 ways:

- **STILLS:** the message includes a picture of the visitor and the recorded audio message (160 messages max).
- **VIDEOS:** the message includes a video feed (duration 16 seconds) and the recorded audio message (18 messages max).

Each message will be given a progressive number, which will be displayed on the video handset, together with the date and time information.

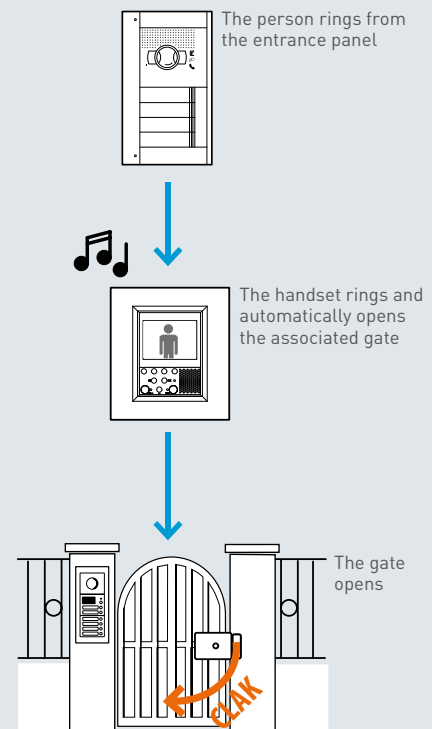

OFFICE FUNCTION

This function is used mainly in the service sector (offices, doctors, professionals) and in all those situations, where the opening of the gate or entrance door without physical interaction with the handset is necessary.

When someone calls from the entrance panel, the handset will ring and the associated gate will open automatically (door lock), without the need for someone to press the door lock key on the handset itself.

When the function is activated, the video handset red LED will also flash.

AUDIO AND VIDEO SOLUTIONS

SECTION 1 KIT solutions



AUDIO AND VIDEO (4 WIRES)

FOR ONE-FAMILY HOME

AUDIO E VIDEO (2 WIRES)

FOR ONE-FAMILY AND TWO-FAMILY HOME

- one-family and two-family audio kit
- one-family and two-family black and white audio kit
- one-family and two-family colour audio kit

Ready packed solutions

(only one item code)



SECTION

1



SECTION

2



SECTION

3



SECTION **2** **MULTI-FAMILY**
solutions

WITH SFERA NEW
AND SFERA ROBUR
ENTRANCE PANELS



AUDIO AND VIDEO

FOR BUILDINGS WITH 3 TO 5
APARTMENTS

- audio solutions with SFERA NEW and SFERA ROBUR entrance panels
- video solutions with SFERA NEW and SFERA ROBUR entrance panels

customised
solutions

(with list of item codes
and wiring diagrams)



SECTION **3** **ADVANCED**
solutions



AUDIO AND VIDEO

FOR MORE THAN 5 APARTMENTS AND
HOME AUTOMATION APPLICATIONS

- the system for the apartment building complex or the group of individual homes
- system with advanced functions
- integrated system with home automation functions

design your system
using the BTicino
technical guide



4 WIRE AND 2 WIRE AUDIO VIDEO KITS

The **4 wire kits** are the most economical and competitive solution for creating **ONE – FAMILY** audio and video door entry system.

With a single reference code, the kit includes all the items required for the installation of the system: entrance

panel and handset. All analogue and video kits can be installed very easily: each handset has an easy plug-in power connector. They have a door lock release key, and INTERCOM function (expansion up to a maximum of 3 handset).



The **2 WIRE kits** are suitable for creating **ONE-FAMILY** or **TWO-FAMILY** audio and video door entry systems for the residential sector. They are fully expandable and are suitable for all installation requirements. Full compatibility with 2 WIRE range of devices (entrance panels, audio handset, video handset, system accessories and indoor or outdoor cameras), ensuring a possibility of expansion without limitations.

All analog and 2 WIRE kits include a manual with all technical information required for the installation, the connection, and the putting into operation of the system, as well as an explanation of system features.

4 WIRE AUDIO AND VIDEO KITS

Catalogue

ONE-FAMILY VIDEO SYSTEM

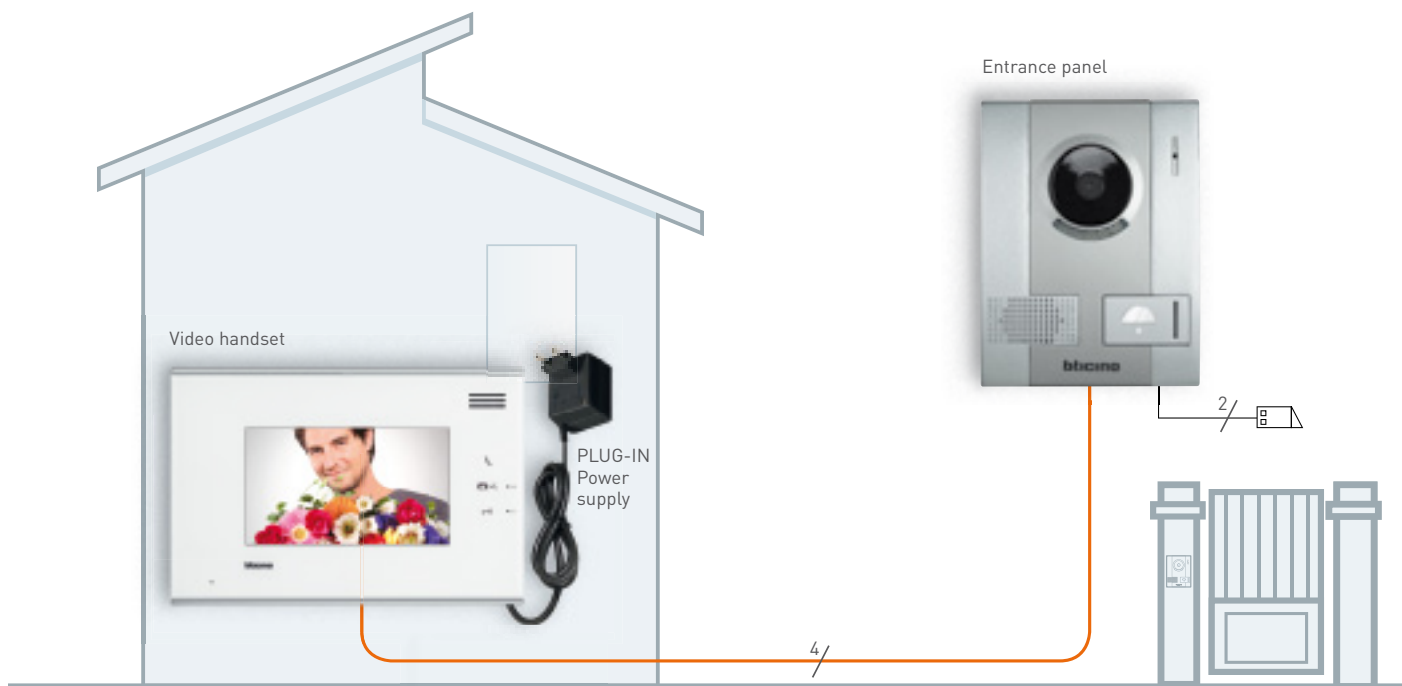

WIRING DIAGRAM

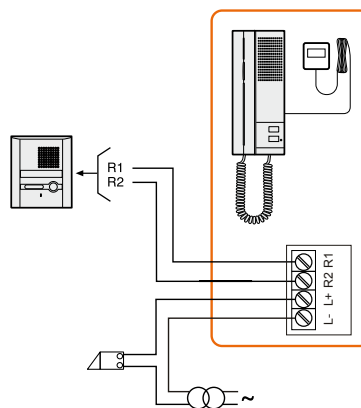

WIRING DIAGRAM WITH ADDITIONAL AUDIO HANDSETS

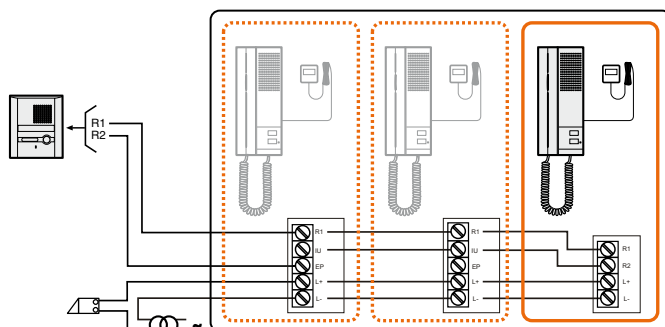

Item	AUDIO KIT
316113	ONE-FAMILY analogue audio kit with wall mounted dedicated entrance panel and handset. PLUG-IN system power supply included. It can be expanded with up to 3 dedicated handsets
Composition	Quantity
Audio handset	1
Pushbutton panel	1
ACCESSORIES	
331453	additional audio handset for kit 316113
331460	outdoor pushbutton panel (replacement)
336842	230/12 18 VA transformer for electric door lock

4 WIRE AUDIO AND VIDEO KITS

Catalogue



Item	BLACK AND WHITE VIDEO KIT
316213	ONE-FAMILY analogue B/W video kit with wall mounted dedicated entrance panel and handset. Entrance panel with pinhole camera. Video handset with 3.5" B/W monitor and Standard Euro Plug for system power supply. It can be expanded with up to 3 dedicated handsets
Composition	Quantity
Video Handset	1
Pushbutton panel	1

ACCESSORIES	
331553	additional video handsets for Video kit item 316213
331560	outdoor pushbutton panel (replacement)
336842	230/12 18 VA transformer for electric door lock

WIRING DIAGRAM (THE DOTTED LINES REPRESENT THE DIAGRAM FOR ADDITIONAL VIDEO HANDSETS)

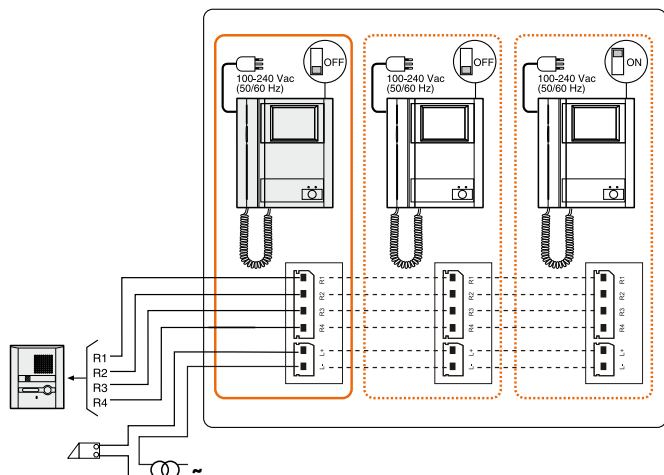

Item	BLACK AND WHITE VIDEO KIT
316313	ONE-FAMILY analogue B/W video handsfree kit with wall mounted dedicated entrance panel and handset. Entrance panel with pinhole camera. Video handset with 3.5" B/W monitor and standard Euro Plug for system power supply. It can be expanded with up to 3 dedicated handsets
Composition	Quantity
Handsfree Video Handset	1
Pushbutton panel	1

ACCESSORI	
331653	additional handsfree video handset for Video handsfree video kit item 316313
331560	outdoor pushbutton panel (replacement)
336842	230/12 18 VA transformer for electric door lock

WIRING DIAGRAM (THE DOTTED LINES REPRESENT THE DIAGRAM FOR ADDITIONAL VIDEO HANDSETS)

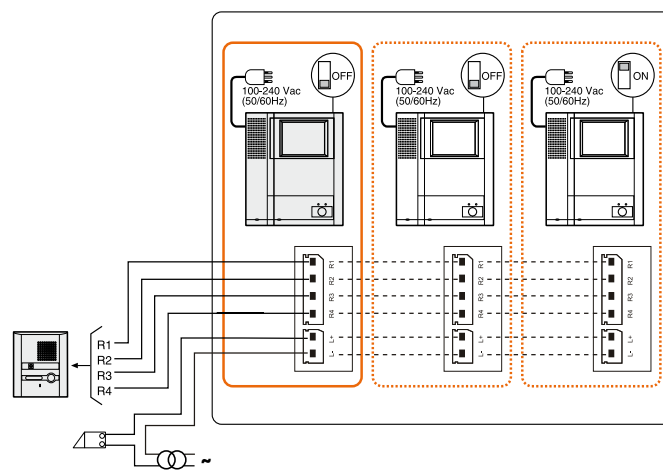



Item	COLOUR VIDEO KIT
316413	ONE-FAMILY analogue colour video kit with wall mounted dedicated entrance panel and video handset. Metal entrance panel with colour camera and LED for the illumination of the field of view. Video handset with 3.5" colour monitor and Standard Euro Plug for system power supply. It can be expanded with up to 3 dedicated handsets
Composition	Quantity
Video Handset	1
Pushbutton panel	1

ACCESSORIES	
331753	colour video handset with receiver for video kit item 316413
336842	230/12 18 VA transformer for electric door lock

WIRING DIAGRAM (THE DOTTED LINES REPRESENT THE DIAGRAM FOR ADDITIONAL VIDEO HANDSETS)

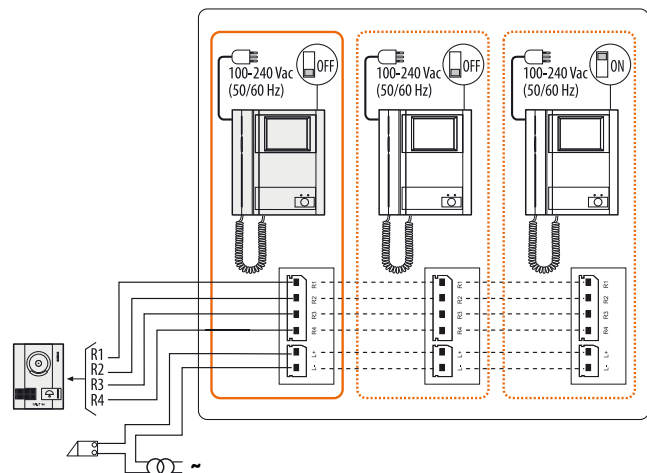

Item	HANDSFREE COLOUR VIDEO KIT
316513	ONE-FAMILY analogue colour video handsfree kit with wall mounted dedicated entrance panel and video handset. Metal entrance panel with colour camera and LED for the illumination of the field of view. Video handset with 7" colour monitor and PLUG-IN system power supply included. It can be expanded with up to 3 dedicated handsets
Composition	Quantity
Handsfree Video Handset	1
Pushbutton panel	1

ACCESSORIES	
331853	handsfree colour video handset for handsfree video kit item 316513
336842	230/12 18 VA transformer for electric door lock

WIRING DIAGRAM (THE DOTTED LINES REPRESENT THE DIAGRAM FOR ADDITIONAL VIDEO HANDSETS)

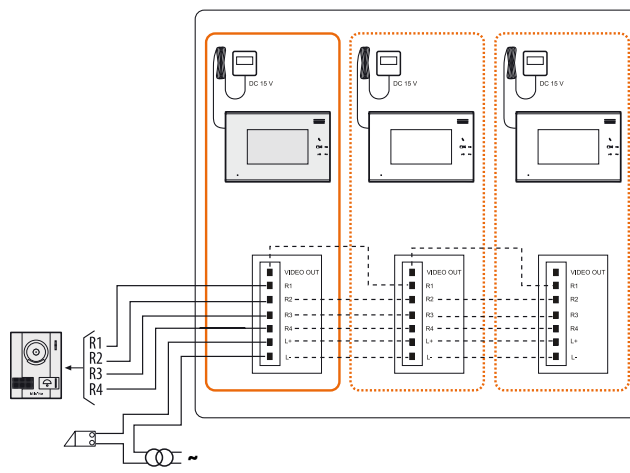

2 WIRE AUDIO AND VIDEO KITS

Catalogue

ONE-FAMILY AUDIO SYSTEM

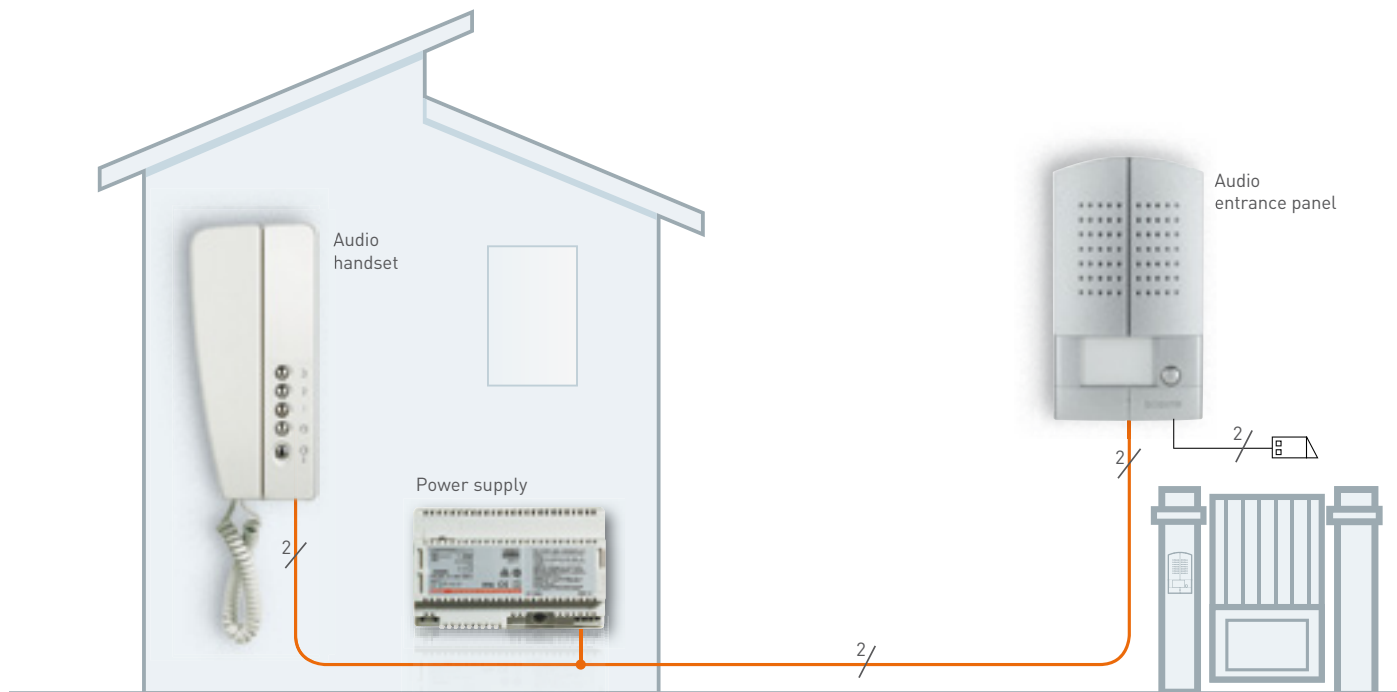

Item	SWING AUDIO KIT - LINEA 2000 METAL
368111	one-family kit with SWING handset and LINEA 2000 METAL pushbutton panel. 2 WIRE technology. Devices suitable for wall mounted installation. The pushbutton panel has an IK10 protection index against mechanical impact
368121	two-family kit with SWING handsets and LINEA 2000 METAL pushbutton panel. 2 WIRE technology. The pushbutton panel has an IK10 protection index against mechanical impact



Item	SWING AUDIO KIT - MODULAR SFERA CLASSIC
367211	one-family kit with SWING handset and SFERA CLASSIC modular pushbutton panel in Allmetal finish. 2 WIRE technology. Handset suitable for wall mounted installation. Pushbutton panel suitable for flush mounted installation
367221	two-family kit with SWING handsets and SFERA CLASSIC modular pushbutton panel in Allmetal finish. 2 WIRE technology. Handsets suitable for wall mounted installation. Pushbutton panel suitable for flush mounted installation

TWO-FAMILY VIDEO SYSTEM

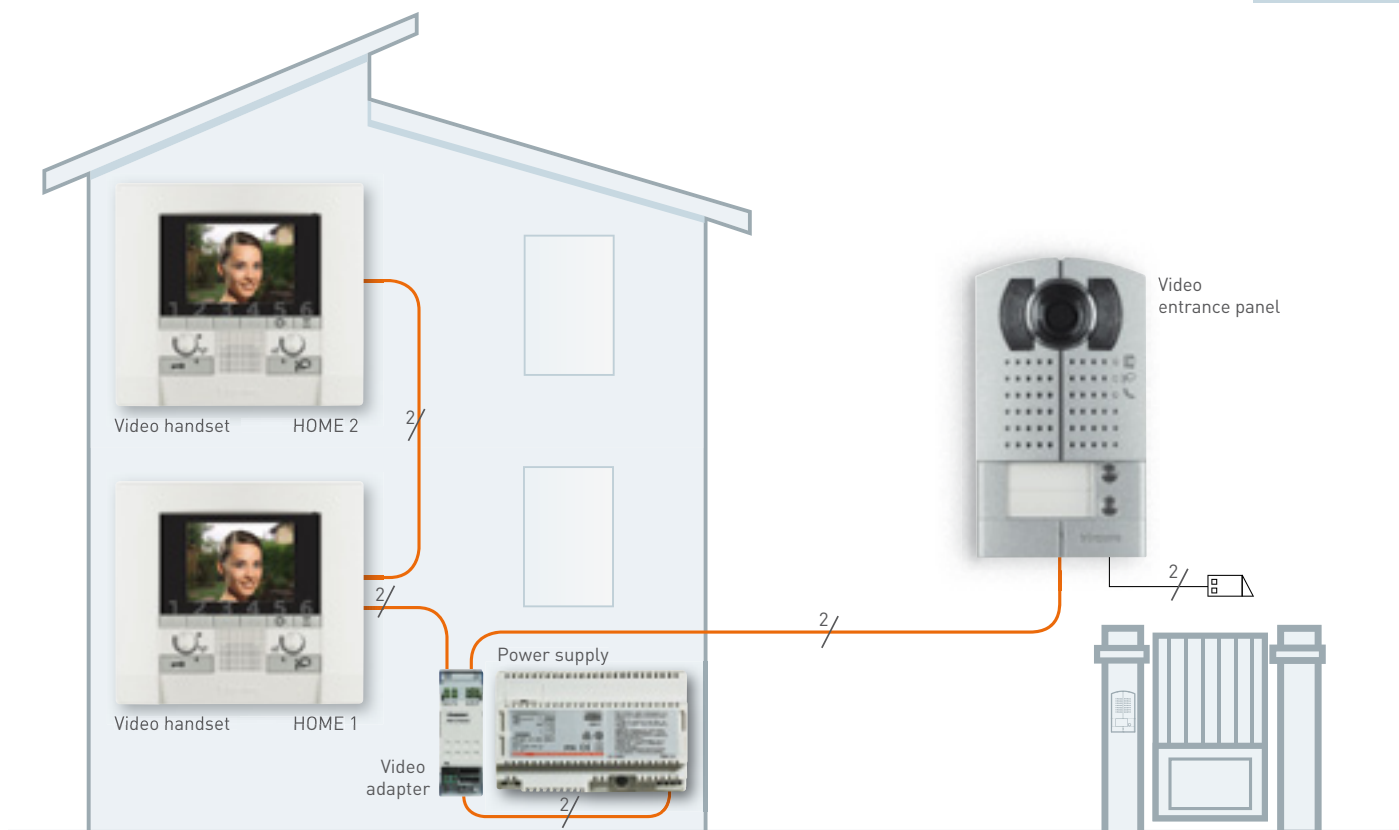

Item	SWING BASE VIDEO KIT - LINEA 2000
365411	one-family video (black & white) kit with SWING BASE 4" video handset and LINEA 2000 pushbutton panel. 2 WIRE technology. Devices suitable for wall mounted installation.
365421	two-family video (black & white) kit with SWING BASE 4" video handsets and LINEA 2000 pushbutton panel. 2 WIRE technology. Devices suitable for wall mounted installation.



Item	SWING VIDEO KIT - LINEA 2000 METAL
367511	one-family video (colour) kit with SWING 4" video handset and LINEA 2000 pushbutton panel. 2 WIRE technology. Devices suitable for wall mounted installation. The pushbutton panel has an IK10 protection index against mechanical impact
367521	two-family video (colour) kit with SWING 4" video handsets and LINEA 2000 pushbutton panel. 2 WIRE technology. Devices suitable for wall mounted installation. The pushbutton panel has an IK10 protection index against mechanical impact

2 WIRE AUDIO AND VIDEO KITS

Catalogue



POLYX VIDEO HANDSFREE KIT - LINEA 2000 METAL WALL MOUNTED INSTALLATION

Item	
368911	one-family handsfree video (colour) kit with POLYX VIDEO 3.5" handset and LINEA 2000 pushbutton panel. 2 WIRE technology. Devices suitable for wall mounted installation. The pushbutton panel has an IK10 protection index against mechanical impact
368921	two-family handsfree video (colour) kit with POLYX VIDEO 3.5" handset and LINEA 2000 METAL pushbutton panel. 2 WIRE technology. Devices suitable for wall mounted installation. The pushbutton panel has an IK10 protection index against mechanical impact



POLYX VIDEO HANDSFREE KIT - LINEA 2000 METAL FLUSH MOUNTED INSTALLATION

Item	
368811	one-family handsfree video (colour) kit with POLYX VIDEO 3.5" handset and LINEA 2000 pushbutton panel for flush mounted installation. 2 WIRE technology. Handset suitable for wall mounted installation. Pushbutton panel suitable for flush mounted installation. The pushbutton panel has an IK10 protection index against mechanical impact
368821	two-family handsfree video (colour) kit with POLYX VIDEO 3.5" handsets and LINEA 2000 pushbutton panel for flush mounted installation. 2 WIRE technology. Handset suitable for wall mounted installation. Pushbutton panel suitable for flush mounted installation. The pushbutton panel has an IK10 protection index against mechanical impact



POLYX MEMORY DISPLAY HANDSFREE KIT WITH MEMORY - LINEA 2000 METAL WALL MOUNTED INSTALLATION

Item	
369411	one-family handsfree kit with call memory and colour video display consisting of POLYX MEMORY DISPLAY 3.5" video handset and LINEA 2000 METAL pushbutton panel. The video handset has an icon menu for the control of video door entry functions and MY HOME automation functions. 2 WIRE technology. Devices suitable for wall mounted installation. The pushbutton panel has an IK10 protection index against mechanical impact
369421	Two-family handsfree kit with call memory and colour video display consisting of POLYX MEMORY DISPLAY 3.5" video handset and LINEA 2000 METAL pushbutton panel. The video handsets have icon menus for the control of video door entry functions and MY HOME automation functions. 2 WIRE technology. Devices suitable for wall mounted installation. The pushbutton panel has an IK10 protection index against mechanical impact



POLYX MEMORY DISPLAY HANDSFREE KIT WITH MEMORY - LINEA 2000 METAL FLUSH MOUNTED INSTALLATION

Item	
369511	one-family handsfree kit with call memory and colour video display consisting of POLYX MEMORY DISPLAY 3.5" video handset and LINEA 2000 METAL pushbutton panel for flush mounted installation. The video handset has an icon menu for the control of video door entry functions and MY HOME automation functions. 2 WIRE technology. Devices suitable for wall mounted installation. Pushbutton panel suitable for flush mounted installation. The pushbutton panel has an IK10 protection index against mechanical impact
369521	two-family handsfree kit with call memory and colour video display consisting of POLYX MEMORY DISPLAY 3.5" video handset and LINEA 2000 METAL pushbutton panel for flush mounted installation. The video handset have icon menus for the control of video door entry functions and MY HOME automation functions. 2 WIRE technology. Devices suitable for wall mounted installation. Pushbutton panel suitable for flush mounted installation. The pushbutton panel has an IK10 protection index against mechanical impact

INDEX

MULTI APARTMENT SOLUTIONS

Audio solution for 3 apartments	22
Audio solution for 4 apartments	23
Audio solution for 5 apartments	24
Audio handset variants and configuration	25
Video solution for 3 apartments	26
Video solution for 4 apartments	27
Video solution for 5 apartments	28
Video handset variants and configuration	29

AUDIO SOLUTION FOR 3 APARTMENTS

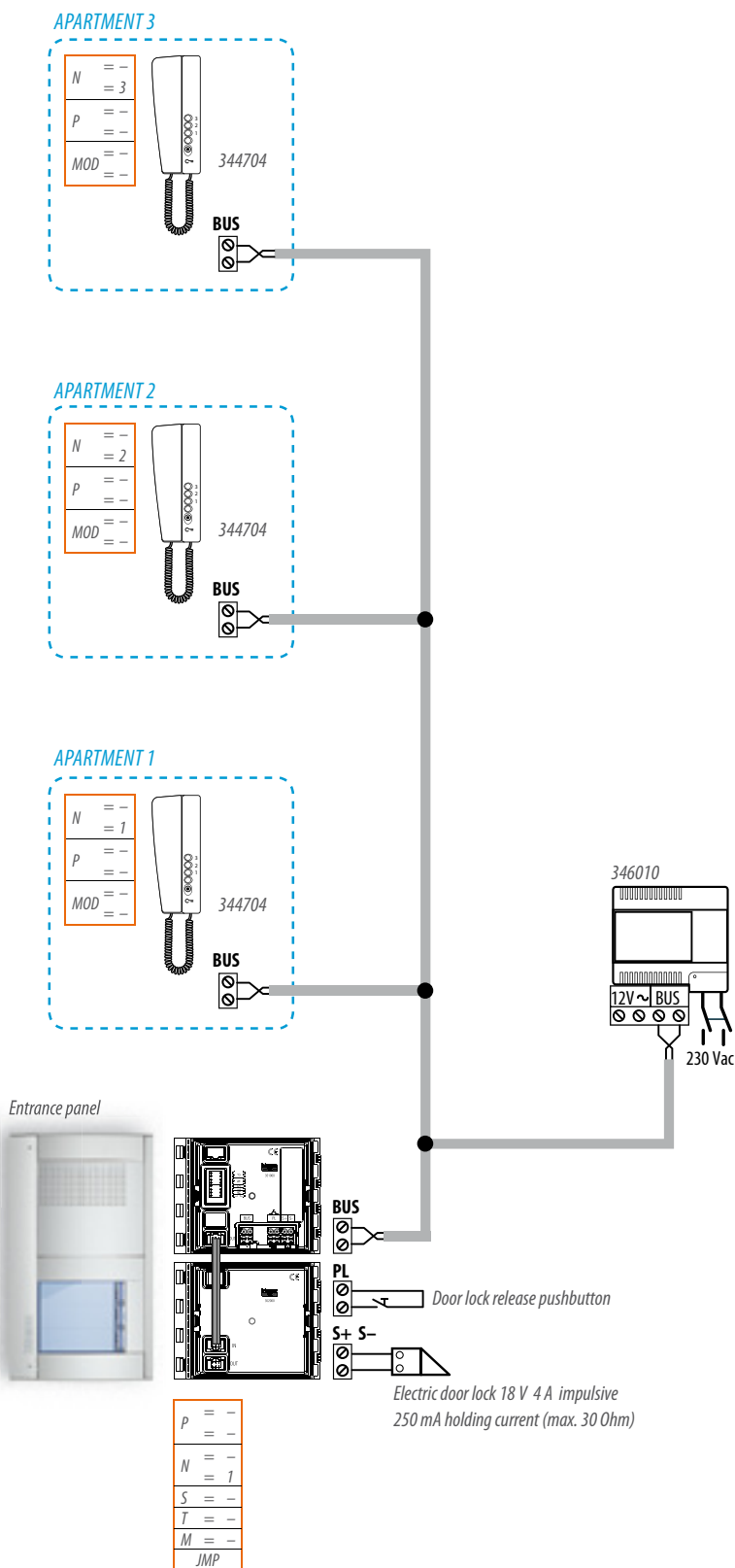

SYSTEM WITH SFERA NEW ENTRANCE PANEL

ITEM	DESCRIPTION	QTY
350020	SFERA NEW 2 module flush mounted box	1
35022..	SFERA NEW 2 module support frame (see finishes)	1
351000	SFERA NEW audio porter module	1
352000	SFERA NEW additional pushbutton module	1
35100..	SFERA NEW porter module front cover (see finishes)	1
35203..	SFERA NEW pushbutton module front cover (see finishes)	1
346010	Audio system power supply	1
344704	SWING audio handset	3
3501/1	Configurator 1	2
3501/2	Configurator 2	1
3501/3	Configurator 3	1
3502	Extractor clamp	1
346250	Gate opening relay module	1

Replace the dots in the code with the number corresponding to the desired colour:

1. Allmetal
2. Allwhite
3. Allstreet



SYSTEM WITH SFERA ROBUR ENTRANCE PANEL

ITEM	DESCRIPTION	QTY
350120	SFERA ROBUR 2 module flush mounted box	1
350325	SFERA ROBUR 2 module support frame	1
351000	SFERA audio porter module	1
352000	SFERA additional pushbutton module	1
351005	SFERA ROBUR porter module front cover	1
352035	SFERA ROBUR pushbutton module front cover	1
350425	SFERA ROBUR 2 module finishing frame	1
346010	Audio system power supply	1
344704	SWING audio handset	3
3501/1	Configurator 1	2
3501/2	Configurator 2	1
3501/3	Configurator 3	1
3502	Extractor clamp	1
346250	Gate opening relay module	1



Sfera Robur

NOTE: for pushbutton entrance panel with more than 5 calls, refer to 2 wire video door entry system technical guide

AUDIO SOLUTION FOR 4 APARTMENTS

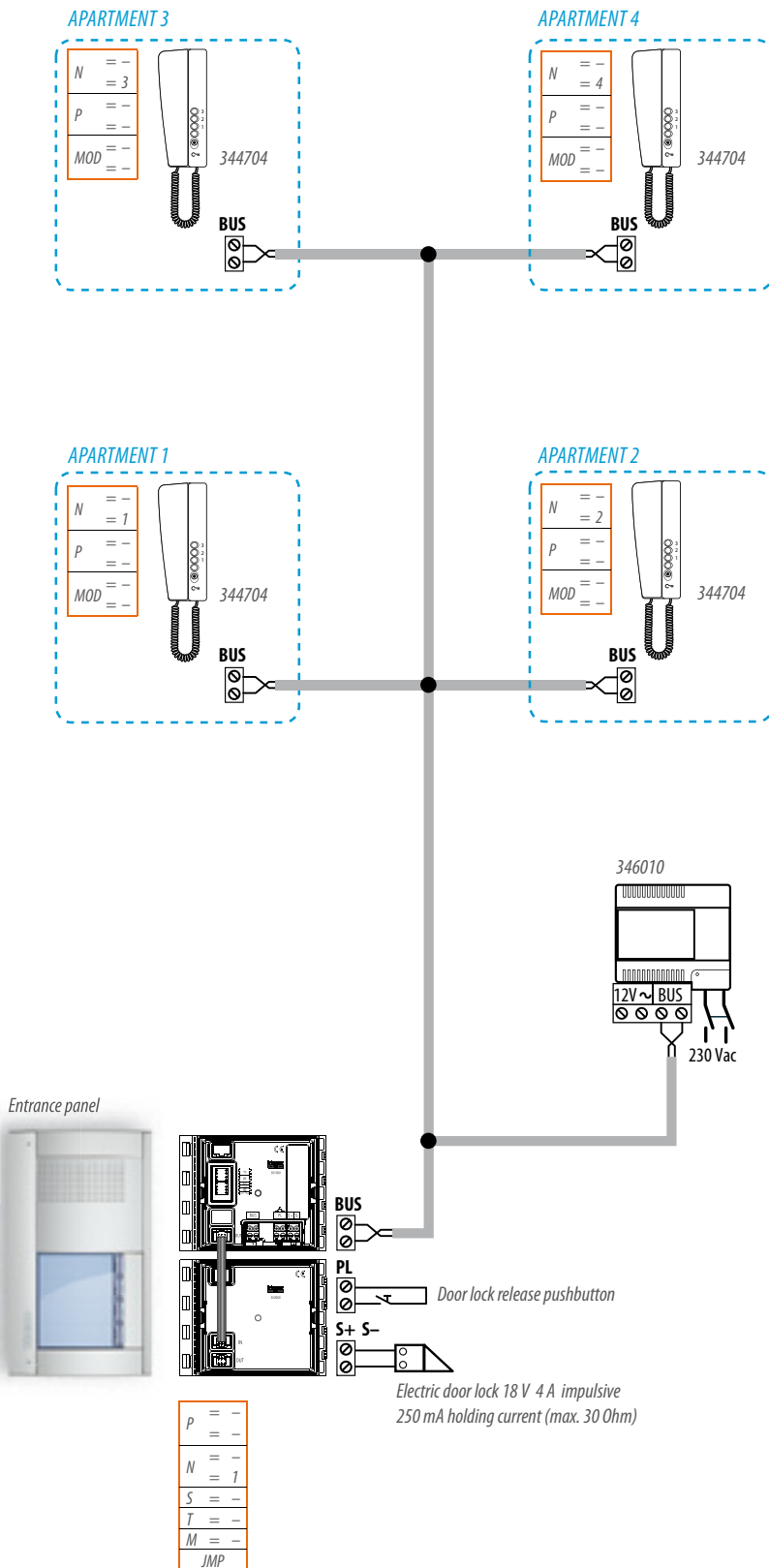

SYSTEM WITH SFERA NEW ENTRANCE PANEL

ITEM	DESCRIPTION	QTY
350020	SFERA NEW 2 module flush mounted box	1
35022..	SFERA NEW 2 module support frame (see finishes)	1
351000	SFERA NEW audio porter module	1
352000	SFERA NEW additional pushbutton module	1
35100..	SFERA NEW porter module front cover (see finishes)	1
35204..	SFERA NEW pushbutton module front cover (see finishes)	1
346010	Audio system power supply	1
344704	SWING audio handset	4
3501/1	Configurator 1	2
3501/2	Configurator 2	1
3501/3	Configurator 3	1
3501/4	Configurator 4	1
3502	Extractor clamp	1
346250	Gate opening relay module	1

Replace the dots in the code with the number corresponding to the desired colour:

1. Allmetal

2. Allwhite

3. Allstreet



SYSTEM WITH SFERA ROBUR ENTRANCE PANEL

ITEM	DESCRIPTION	QTY
350120	SFERA ROBUR 2 module flush mounted box	1
350325	SFERA ROBUR 2 module support frame	1
351000	SFERA audio porter module	1
352000	SFERA additional pushbutton module	1
351005	SFERA ROBUR porter module front cover	1
352045	SFERA ROBUR pushbutton module front cover	1
350425	SFERA ROBUR 2 module finishing frame	1
346010	Audio system power supply	1
344704	SWING audio handset	4
3501/1	Configurator 1	2
3501/2	Configurator 2	1
3501/3	Configurator 3	1
3501/4	Configurator 4	1
3502	Extractor clamp	1
346250	Gate opening relay module	1



Sfera Robur

NOTE: for pushbutton entrance panel with more than 5 calls, refer to 2 wire video door entry system technical guide

AUDIO SOLUTION FOR 5 APARTMENTS

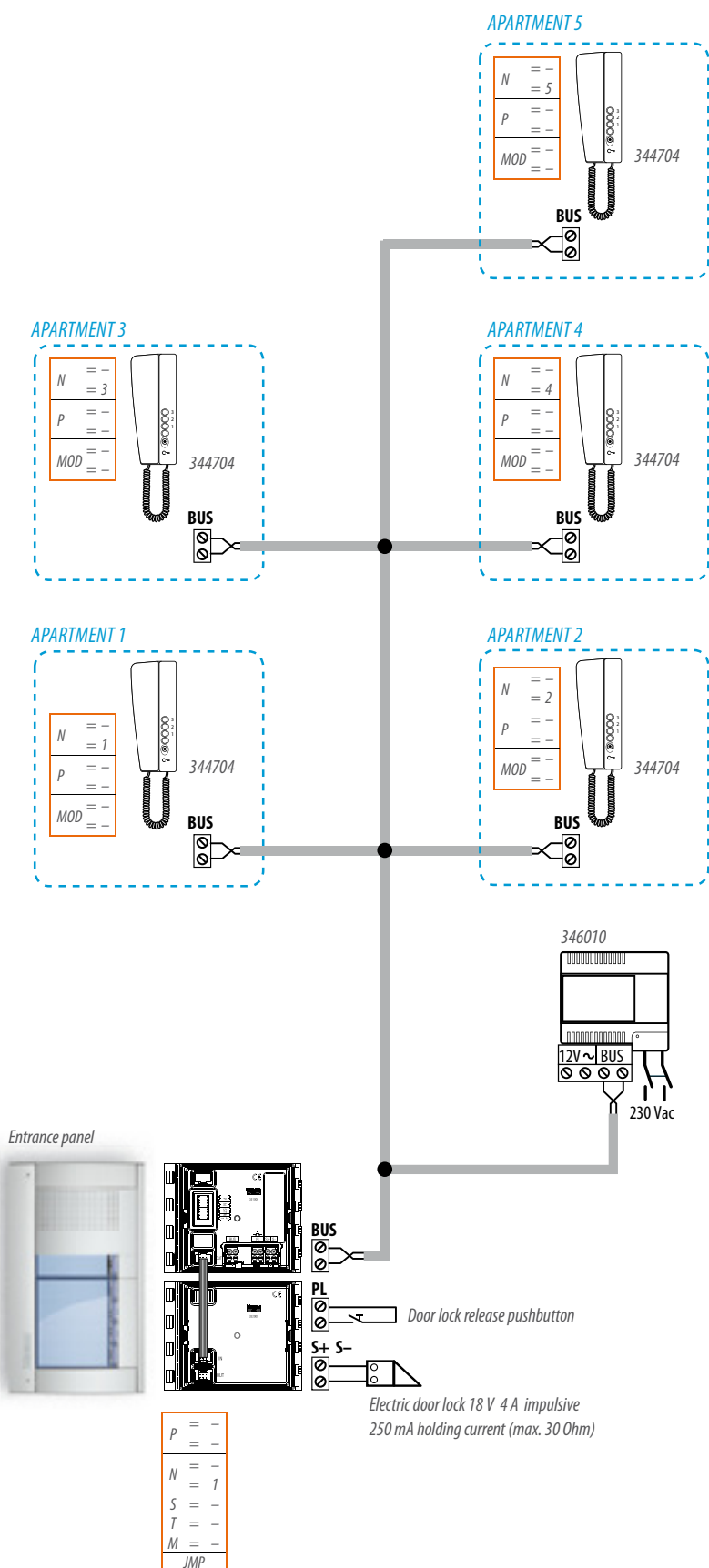

SYSTEM WITH SFERA NEW ENTRANCE PANEL

ITEM	DESCRIPTION	QTY
350020	SFERA NEW 2 module flush mounted box	1
35022..	SFERA NEW 2 module support frame (see finishes)	1
351000	SFERA NEW audio porter module	1
352000	SFERA NEW additional pushbutton module	1
35101..	SFERA NEW porter module front cover (see finishes)	1
35204..	SFERA NEW pushbutton module front cover (see finishes)	1
346010	Audio system power supply	1
344704	SWING audio handset	5
3501/1	Configurator 1	2
3501/2	Configurator 2	1
3501/3	Configurator 3	1
3501/4	Configurator 4	1
3501/5	Configurator 5	1
3502	Extractor clamp	1
346250	Gate opening relay module	1

Replace the dots in the code with the number corresponding to the desired colour:

1. Allmetal
2. Allwhite
3. Allstreet



SYSTEM WITH SFERA ROBUR ENTRANCE PANEL

ITEM	DESCRIPTION	QTY
350120	SFERA ROBUR 2 module flush mounted box	1
350325	SFERA ROBUR 2 module support frame	1
351000	SFERA audio porter module	1
352000	SFERA additional pushbutton module	1
351015	SFERA ROBUR porter module front cover	1
352045	SFERA ROBUR pushbutton module front cover	1
350425	SFERA ROBUR 2 module finishing frame	1
346010	Audio system power supply	1
344704	SWING audio handset	3
3501/1	Configurator 1	2
3501/2	Configurator 2	1
3501/3	Configurator 3	1
3501/4	Configurator 4	1
3501/5	Configurator 5	1
3502	Extractor clamp	1
346250	Gate opening relay module	1



NOTE: for pushbutton entrance panel with more than 5 calls, refer to 2 wire video door entry system technical guide

Audio handset variants

The following handsets can be installed (without distinction) in the audio system:



**SPRINT
HANDSETS**

344202
344212



**NEW AUDIO
HANDSET**

344242



**SWING
HANDSET**

344704



**POLYX AUDIO
HANDSFREE**

344082

AUDIO DEVICE CONFIGURATION

The configuration of the devices is obtained by connecting to the appropriate sockets of the entrance panels and the handsets special components called configurators, identified by specific numbers and graphics. To configure the devices refer to the FUNCTIONAL DIAGRAM.

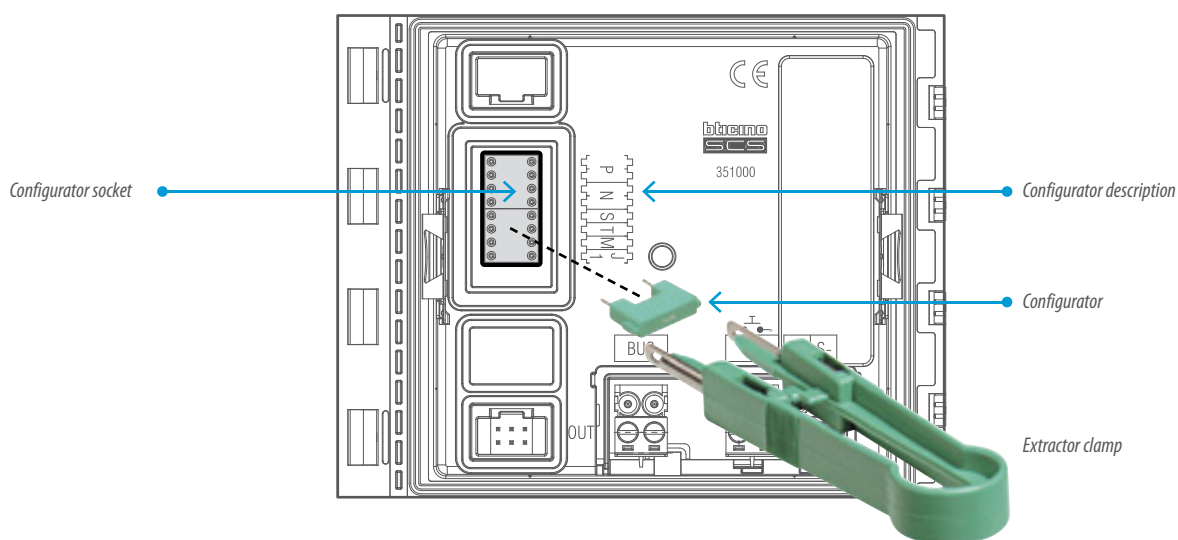

WARNING
Configure the devices with the system **NOT POWERED**.
The Item code of the configurators is for packs of 10 pieces.

VIDEO SOLUTION FOR 3 APARTMENTS

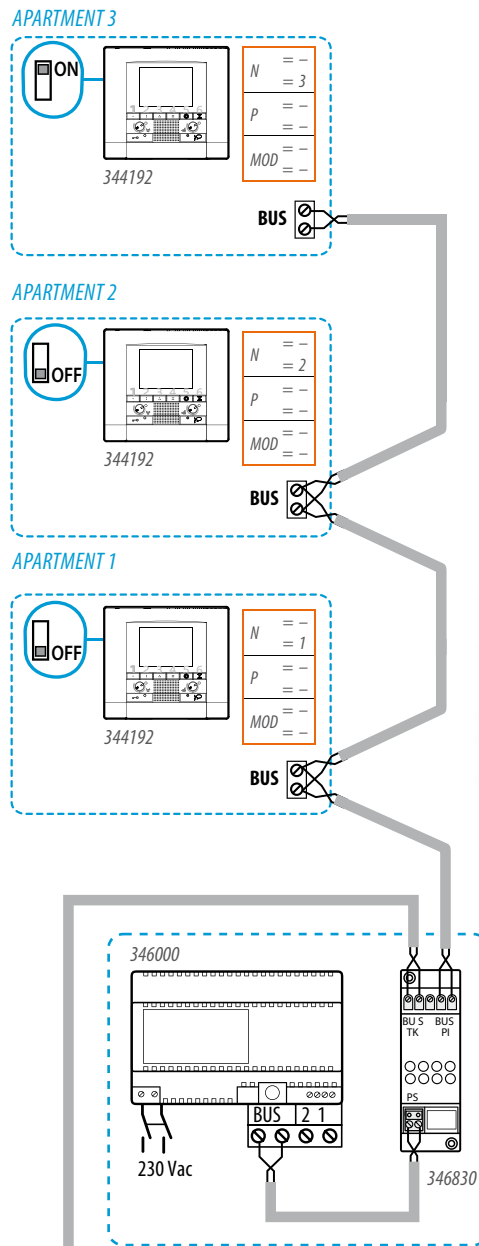

SYSTEM WITH SFERA NEW ENTRANCE PANEL

ITEM	DESCRIPTION	QTY
350020	SFERA NEW 2 module flush mounted box	1
35022..	SFERA NEW 2 module support frame (see finishes)	1
351200	SFERA NEW audio video porter module	1
352000	SFERA NEW additional pushbutton module	1
35120..	SFERA NEW A/V. porter module front cover (see finishes)	1
35203..	SFERA NEW pushbutton module front cover (see finishes)	1
344192	POLYX VIDEO handsfree indoor handset	3
346000	Video system power supply	1
346830	Video adapter	1
3501/1	Configurator 1	2
3501/2	Configurator 2	1
3501/3	Configurator 3	1
3502	Extractor clamp	1
346250	Gate opening relay module	1

Replace the dots in the code with the number corresponding to the desired colour:

- 1. Allmetal
- 2. Allwhite
- 3. Allstreet



SYSTEM WITH SFERA ROBUR ENTRANCE PANEL

ITEM	DESCRIPTION	QTY
350120	SFERA ROBUR 2 module flush mounted box	1
350325	SFERA ROBUR 2 module support frame	1
351200	SFERA audio video porter module	1
352000	SFERA additional pushbutton module	1
351205	SFERA ROBUR A/V. porter module front cover	1
352035	SFERA ROBUR pushbutton module front cover	1
350425	SFERA ROBUR 2 module finishing frame	1
344192	POLYX VIDEO handsfree indoor handset	3
346000	Video system power supply	1
346830	Video adapter	1
3501/1	Configurator 1	2
3501/2	Configurator 2	1
3501/3	Configurator 3	1
3502	Extractor clamp	1
346250	Gate opening relay module	1

Entrance panel

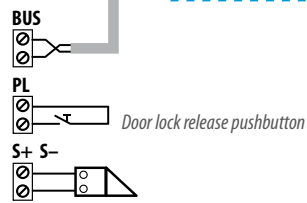
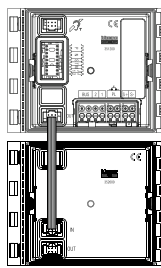

Electric door lock 18V 4A impulsive
250 mA holding current (max. 30 Ohm)

P	=	.
N	=	1
S	=	.
I	=	.
M	=	.
JMP	=	.
JMP	=	.



Sfera Robur

NOTE: for pushbutton entrance panel with more than 5 calls, refer to 2 wire video door entry system technical guide

VIDEO SOLUTION FOR 4 APARTMENTS

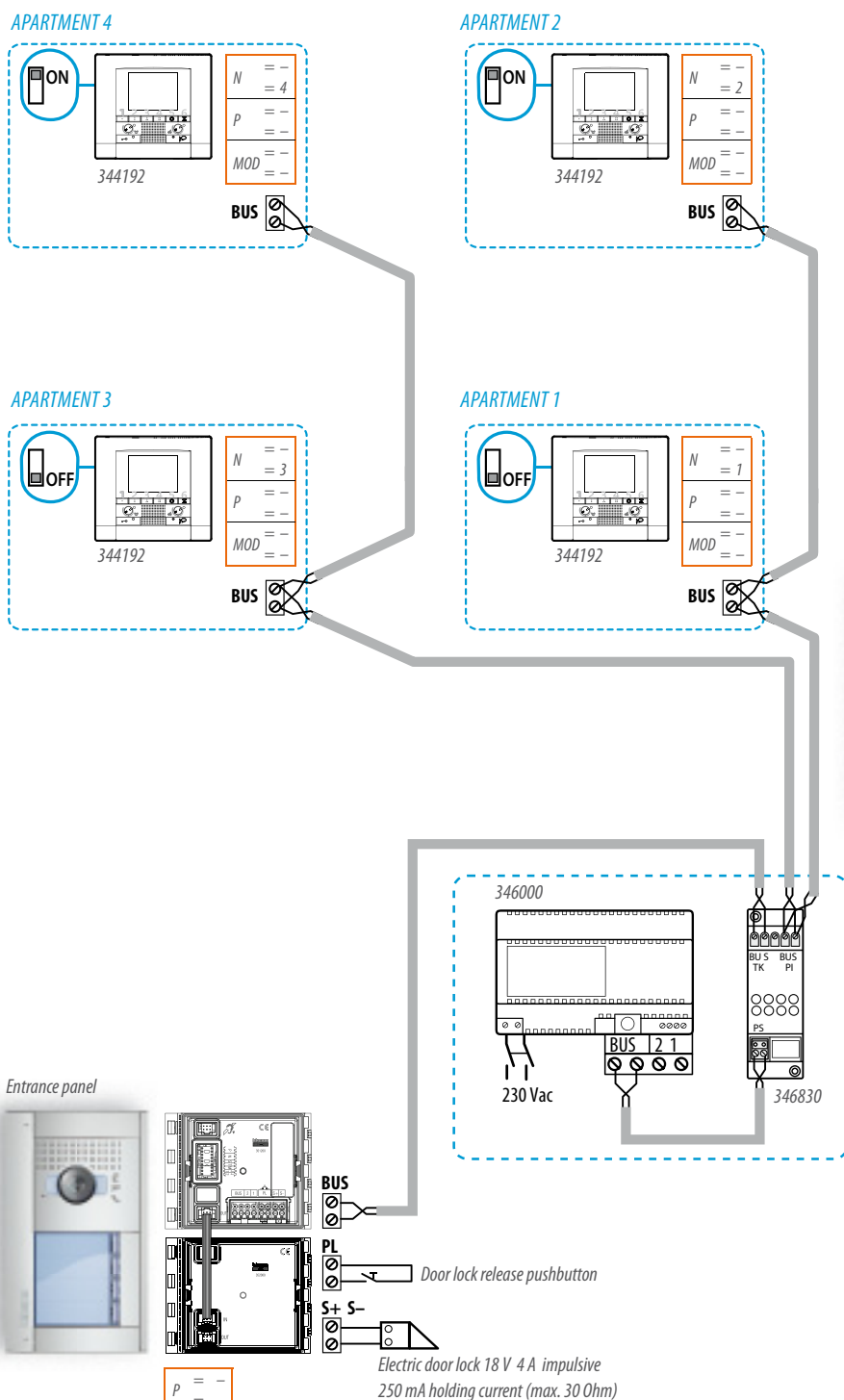

SYSTEM WITH SFERA NEW ENTRANCE PANEL

ITEM	DESCRIPTION	QTY
350020	SFERA NEW 2 module flush mounted box	1
35022..	SFERA NEW 2 module support frame (see finishes)	1
351200	SFERA NEW audio video porter module	1
352000	SFERA NEW additional pushbutton module	1
35120..	SFERA NEW A/V. porter module front cover (see finishes)	1
35204..	SFERA NEW pushbutton module front cover (see finishes)	1
344192	POLYX VIDEO handsfree indoor handset	4
346000	Video system power supply	1
346830	Video adapter	1
3501/1	Configurator 1	2
3501/2	Configurator 2	1
3501/3	Configurator 3	1
3501/4	Configurator 4	1
3502	Extractor clamp	1
346250	Gate opening relay module	1

Replace the dots in the code with the number corresponding to the desired colour:

1. Allmetal
2. Allwhite
3. Allstreet



SYSTEM WITH SFERA ROBUR ENTRANCE PANEL

ITEM	DESCRIPTION	QTY
350120	SFERA ROBUR 2 module flush mounted box	1
350325	SFERA ROBUR 2 module support frame	1
351200	SFERA audio video porter module	1
352000	SFERA additional pushbutton module	1
351205	SFERA ROBUR A/V. porter module front cover	1
352045	SFERA ROBUR pushbutton module front cover	1
350425	SFERA ROBUR 2 module finishing frame	1
344192	POLYX VIDEO handsfree indoor handset	4
346000	Video system power supply	1
346830	Video adapter	1
3501/1	Configurator 1	2
3501/2	Configurator 2	1
3501/3	Configurator 3	1
3501/4	Configurator 4	1
3502	Extractor clamp	1
346250	Gate opening relay module	1



NOTE: for pushbutton entrance panel with more than 5 calls, refer to 2 wire video door entry system technical guide

VIDEO SOLUTION FOR 5 APARTMENTS

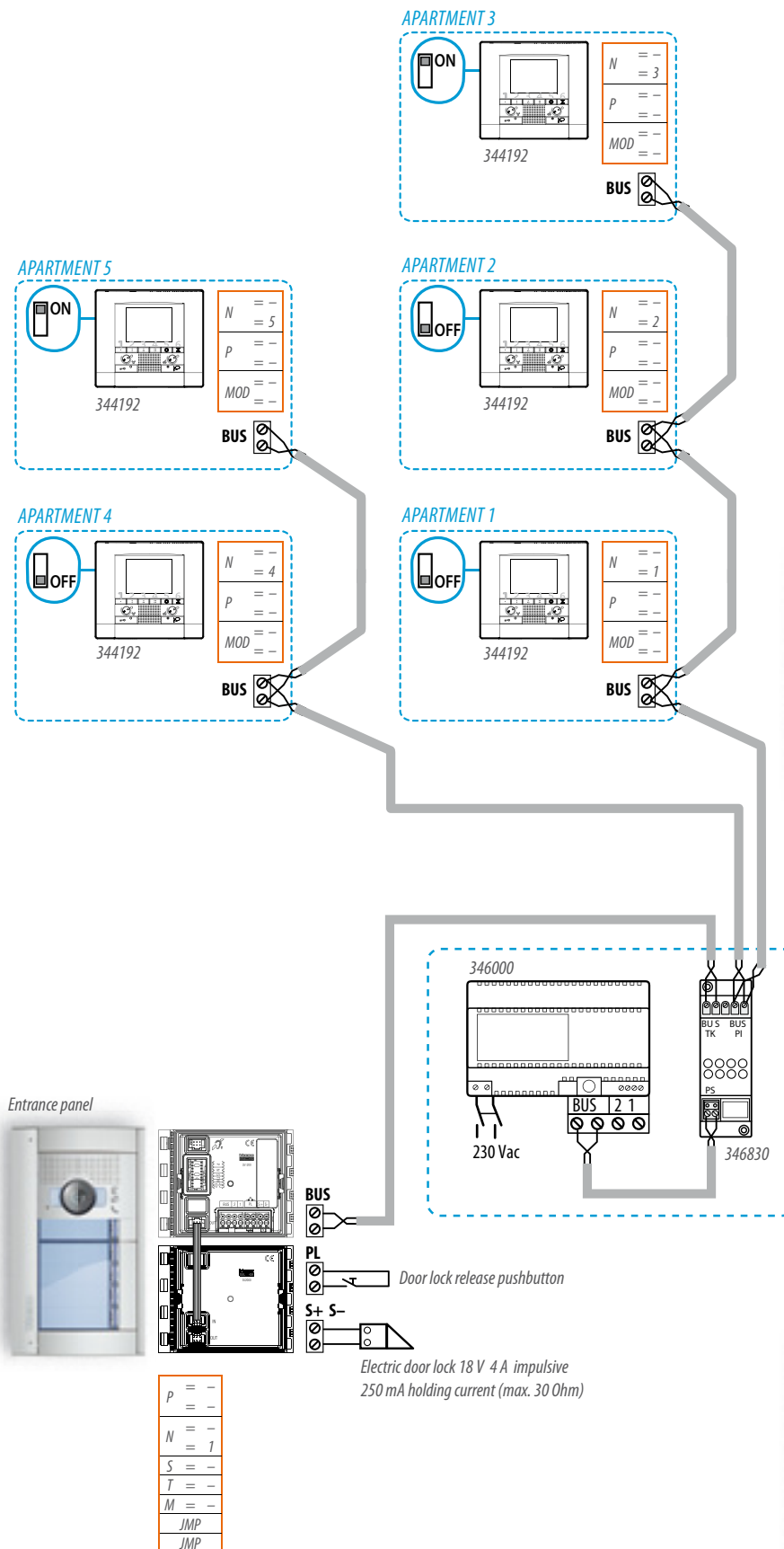

SYSTEM WITH SFERA NEW ENTRANCE PANEL

ITEM	DESCRIPTION	QTY
350020	SFERA NEW 2 module flush mounted box	1
35022..	SFERA NEW 2 module support frame (see finishes)	1
351200	SFERA NEW audio video porter module	1
352000	SFERA NEW additional pushbutton module	1
35121..	SFERA NEW A/V. porter module front cover (see finishes)	1
35204..	SFERA NEW pushbutton module front cover (see finishes)	1
344192	POLYX VIDEO handsfree indoor handset	5
346000	Video system power supply	1
346830	Video adapter	1
3501/1	Configurator 1	2
3501/2	Configurator 2	1
3501/3	Configurator 3	1
3501/4	Configurator 4	1
3501/5	Configurator 5	1
3502	Extractor clamp	1
346250	Gate opening relay module	1

Replace the dots in the code with the number corresponding to the desired colour:

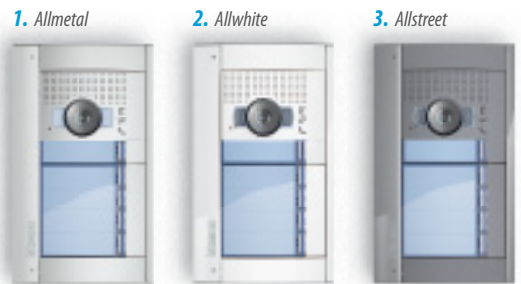

SYSTEM WITH SFERA ROBUR ENTRANCE PANEL

ITEM	DESCRIPTION	QTY
350120	SFERA ROBUR 2 module flush mounted box	1
350325	SFERA ROBUR 2 module support frame	1
351200	SFERA audio video porter module	1
352000	SFERA additional pushbutton module	1
351215	SFERA ROBUR A/V. porter module front cover	1
352045	SFERA ROBUR pushbutton module front cover	1
350425	SFERA ROBUR 2 module finishing frame	1
344192	POLYX VIDEO handsfree indoor handset	5
346000	Video system power supply	1
346830	Video adapter	1
3501/1	Configurator 1	2
3501/2	Configurator 2	1
3501/3	Configurator 3	1
3501/4	Configurator 4	1
3501/5	Configurator 5	1
3502	Extractor clamp	1
346250	Gate opening relay module	1



NOTE: for pushbutton entrance panel with more than 5 calls, refer to 2 wire video door entry system technical guide

Video handset variants

The following video handsets can be installed (without distinction) in the video system:



**SWING
HANDSETS**

344832 (basic b/w monitor)
344824 (colour monitor)



**POLYX
VIDEO**

344192

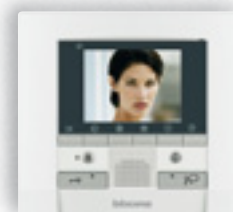

**POLYX MEMORY
DISPLAY**

344163

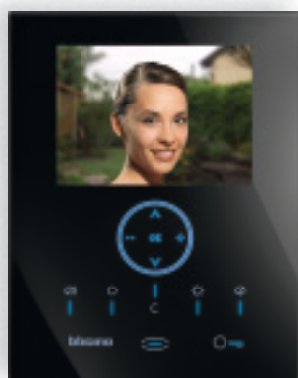

**VIDEO STATION
NIGHTER/WHICE**

349320 NIGHTER
349321 WHICE

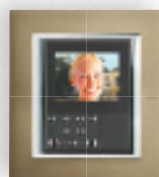

**AXOLUTE
VIDEO DISPLAY**

349311 - Tech
349312 - Antracite
349313 - White
349340 - Etèris



**LIVINGLIGHT
VIDEO DISPLAY**

344400 - LIVINGLIGHT
344401 - LIVINGLIGHT AIR

AXOLUTE and LIVINGLIGHT video displays must be completed with front cover and front cover plate - see the BTicino specific catalogue.

VIDEO DEVICE CONFIGURATION

The configuration of the devices is obtained by connecting to the appropriate sockets of the entrance panels and the handsets special components called configurators, identified by specific numbers and graphics. To configure the devices refer to the FUNCTIONAL DIAGRAM.

Some "advanced" devices may alternatively be configured in advanced mode using the PC and a specific software. This mode gives the possibility of configuring, programming, and updating the device firmware. The download to the device requires a USB-mini USB connection.

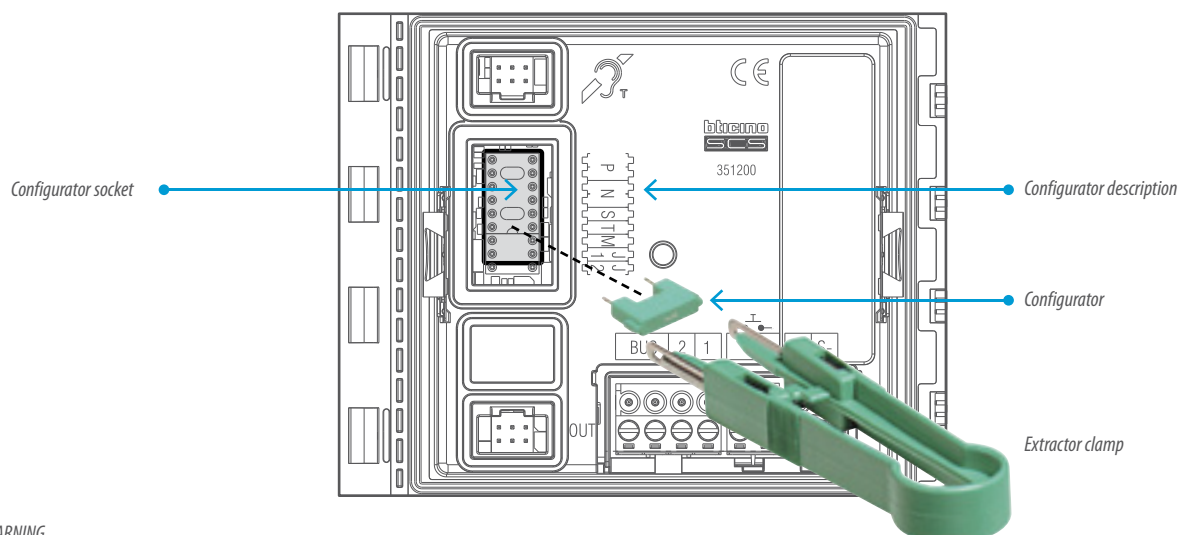

WARNING
Configure the devices with the system NOT POWERED.
The Item code of the configurators is for packs of 10 pieces.

DOOR ENTRY SYSTEM

Advanced solutions

➤ For the installation of 2 WIRE audio and video door entry systems with more than 5 apartments, for apartment building complex systems or systems for groups of individual homes, and to ensure integration with the home automation applications, BTicino provides the professional with a range of technical documentation and a dedicated cost estimate software.



BTicino 2 wire video door entry system
Design and installation guide

➤ **YouDiagram software** for the design of the system and the preparation of estimates - free to download from the website

www.international.bticino.com

➔ ASSISTANCE AND TOOLS

➔ TECHNICAL SOFTWARE

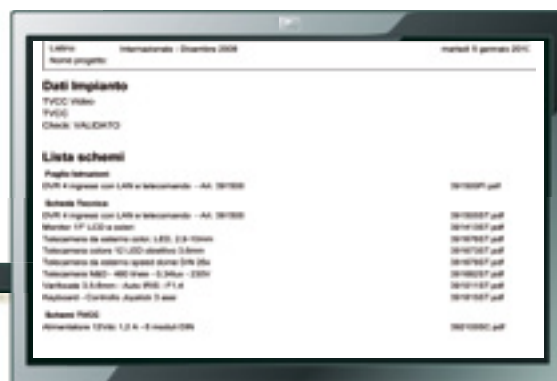

Examples of YouDiagram software screenshots

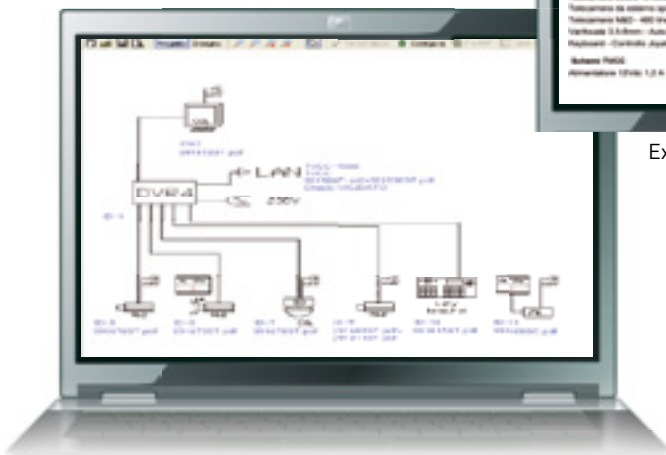

With YouDiagram, just a few steps are enough to produce a system diagram, configure the devices, and check the absorptions on the system BUS.

- For after sales TECHNICAL ASSISTANCE, please refer to the www.international.bticino.com - **BTICINO WORLDWIDE** and www.legrand.com - **WORLD PRESENCE** Web Sites in order to find your nearest subsidiaries :

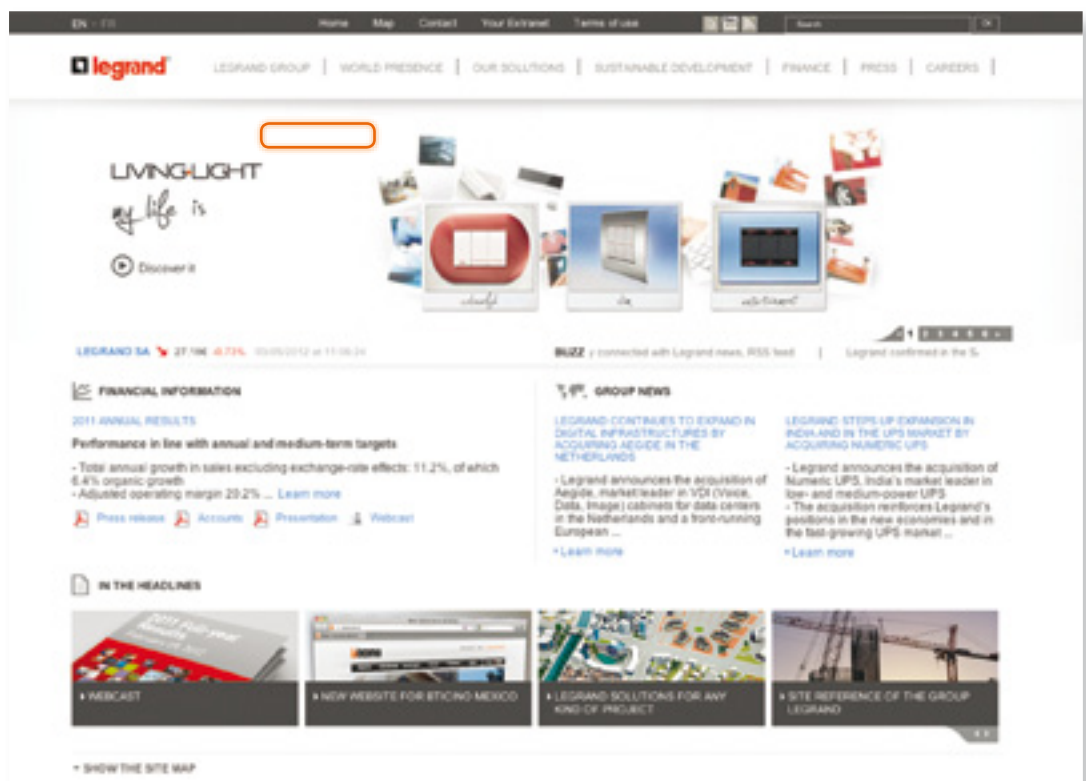

BTicino SpA
Via Messina, 38
20154 Milano - Italy
www.bticino.com

A Group Brand |  **legrand**

bticino

BTicino SpA reserves at any time the right to modify the contents of this booklet and to communicate, in any form and modality, the changes brought to the same.

AD - EXCM12DFKC/UK - Edition 04/2012